

**TRIAD SERIES TRC BALL VALVES**  
**2 - WAY HIGH PRESSURE**  
**CETOP ISO 6164**

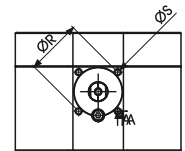

**Specifications:**

- 2 way high pressure ball valve
- Round body
- Carbon Steel and Stainless Steel
- Pressure rating: PN250 - PN350 - PN400 (dependent on size and seal material)
- Temperature: -20°C to 100°C (Carbon Steel)
- -60°C to 230°C (Stainless Steel)
- ISO 5211 Actuator Mounting
- O-rings: NBR, FKM, EPDM, MVQ

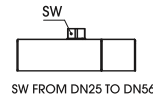
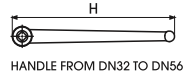
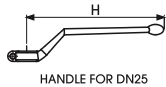
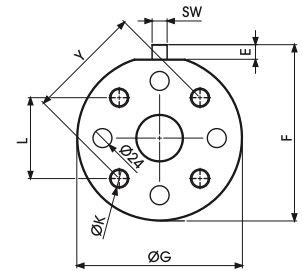
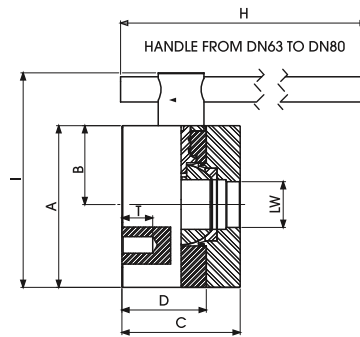

HOLE FOR ACTUATOR ISO5211

**CETOP250 ISO6164 (mm) 25 MPa**

DN	A	B	C	D	E	F	ØG	H	I	L	Y	K	ØR	ØS	ISO5211	T	SW	LW	KG
25	98.5	39.5	88	69	14	113	118	180	146	43.8	62	4xM10	50	M6	F05	20	14	25	6.3
32	143.5	71	100	73	14	162	145	300	171	51.6	73	4xM12	50	M6	F05	21	17	32	12.2
38	160	78	110	80	14	178.5	165	300	187.5	60.1	85	4xM16	50	M6	F05	24.5	17	38	16.9
51	192	93	116	90	14	206	196	300	214.5	69.3	98	4xM16	70	M8	F07	25.5	17	47	32.9
56	192	93	150	107	14	206	203	600	214.5	83.4	118	4xM20	70	M8	F07	33	17	58	32.9
63	205	100	150	107	18	223	210	600	272	102.5	145	4xM20	70	M8	F07	36	19	70	36.6

**CETOP350 ISO6164 (mm) 35 MPa**

DN	A	B	C	D	E	F	ØG	H	I	L	Y	K	ØR	ØS	ISO5211	T	SW	LW	KG
25	102.5	39.5	39.5	69	14	117	118	180	117	50.9	72	4xM12	50	M6	F05	20	14	25	7.2
32	141	68	68	75.5	14	158	145	300	158	56.6	80	4xM16	50	M6	F05	24	17	32	12.5
40	161	78	78	80	14	178	165	300	178	69.5	98	4xM16	50	M6	F05	25	17	38	16.6
50	193	94	94	90	14	210	196	300	210	83.5	118	4xM20	70	M8	F07	28	17	48	25
65	204	100	100	107	21	224	208	600	270	102.5	145	4xM24	70	M8	F07	36	19	63	44
80	208	100	100	107	22	233.5	215	600	279	123.7	175	4xM30	70	M8	F07	36	19	75	45
100	251	122	122	147	26.5	277	258	600	327	141.5	200	8xM24	102	M10	F10	40	24	95	70
125	303	148	148	170	32	330	310	900	389	-	245	8xM30	125	M12	F12	40	36	118	109

**CETOP400 ISO6164 (mm) 40 MPa**

DN	A	B	C	D	E	F	ØG	H	I	L	Y	K	ØR	ØS	ISO5211	T	SW	LW	KG
25	98.5	39.5	88	69	14	113	118	180	146	43.8	62	4xM10	50	M6	F05	20	14	25	6.3
32	143.5	71	100	73	14	162	145	300	171	51.6	73	4xM12	50	M6	F05	21	17	32	12.2
38	160	78	110	80	14	178.5	165	300	187.5	60.1	85	4xM16	50	M6	F05	24.5	17	38	16.9
51	192	93	116	90	14	206	196	300	214.5	69.3	98	4xM16	70	M8	F07	25.5	17	47	32.9
56	192	93	150	107	14	206	203	600	214.5	83.4	118	4xM20	70	M8	F07	33	17	58	32.9
63	205	100	150	107	18	223	210	600	272	102.5	145	4xM20	70	M8	F07	36	19	70	36.6
80	251	122	170	132	26.5	278	258	600	325	123.7	175	4xM30	102	M10	F10	38	24	74	65.4

**TRIAD SERIES TRC BALL VALVES**  
**MATERIAL LIST**

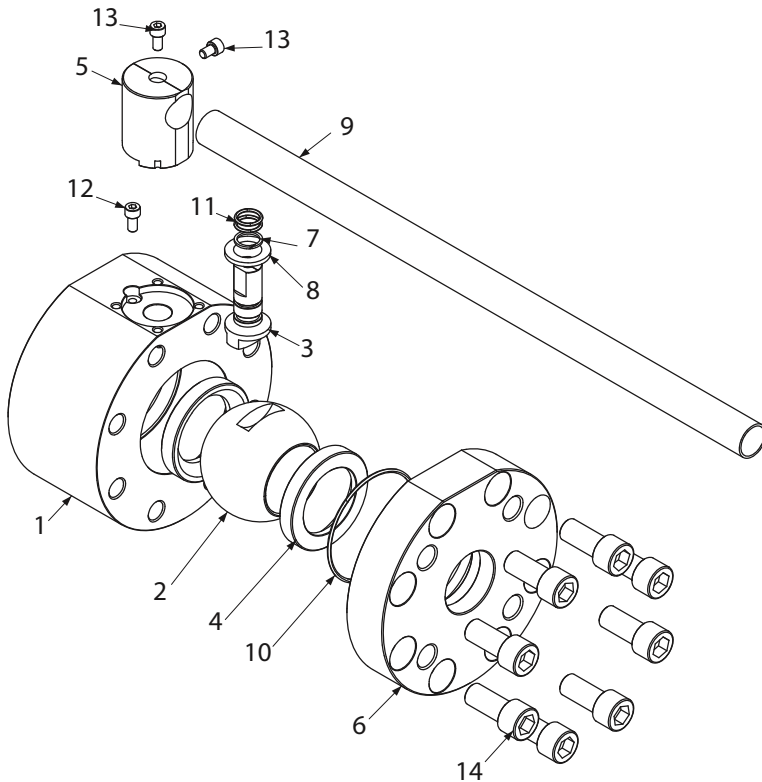

**MATERIAL LIST**

NO	PART NAME	MATERIAL		NO. PCS.
		CS	SS	
1	BODY	1.0570	316L	1
2	BALL	1.0570	316L	1
3	STEM	17 4 PH		1
4	BALL SEAT	POM		2
5	COUPLING	1.0737	316L	1
6	FLANGE	1.0570	316L	1
7	BACK-UP RING	PTFE		1
8	STEM RING	POM		1
9	HANDLE	1.0116	316L	1
10	ADAPTER O-RING	NBR		4
11	STEM O-RING	NBR		2
12	SPINE SCREW	ISO 4762 8.8	ISO 4762 A2	1
13	SCREW	ISO 4762 8.8		2
14	SCREW	ISO 4762 8.8	ISO 4762 A2	8

**Carbon Steel options available upon request:**

O-ring in FKM, EPDM, HNBR, KALREZ  
Seals in PTFE, PEEK, Pa612, RPTFE, Metal Seat  
Stem and Ball in 316L  
Pressure class up to PN40 Mpa  
Locking device

**Stainless Steel options available upon request:**

O-ring in FKM, EPDM, HNBR, KALREZ  
Seals in PTFE, PEEK, Pa612, RPTFE, Metal Seat  
Pressure class up to Pn42 Mpa  
Locking device

**Ordering Information**

TRC-□□-□□□-□□□

<b>Body Material</b>	<b>Pressure</b>	<b>Size</b>	
		025 - DN25	056 - DN56
		032 - DN32	063 - DN63
		038 - DN38	065 - DN65
CS - Carbon Steel	350 - PN350 <small>(only applies to sizes DN25 - DN83)</small>	040 - DN40	080 - DN80
SS - Stainless Steel	400 - PN400 <small>(only applies to sizes DN25 - DN125)</small>	050 - DN50	100 - DN100
		051 - DN51	125 - DN125 <small>(only applies to sizes DN25 - DN80)</small>